

Model 272 PBM THX® THX Select Certified High Performance Powered Subwoofer



 **Atlantic Technology**®
INNOVATIVE HOME THEATER

343 Vanderbilt Avenue Norwood, MA 02062 (781) 762-6300 www.atlantictechnology.com

Instruction Manual

MODEL 272 PBM THX

High Performance THX Select Certified Powered Subwoofer

Congratulations on your purchase of an Atlantic Technology 272 PBM THX powered subwoofer. A well designed subwoofer, properly integrated into your system will enhance your listening pleasure dramatically by providing the bass foundation upon which most music and special effects are built.

The 272 PBM THX is capable of delivering very high output levels and wide dynamic range. When properly placed it will provide smooth in-room bass response down to approximately 20Hz, with a peak SPL of over 105dB (2000 cubic foot space).

The built-in proprietary high-current Class A/B amplifier is conservatively rated at 225 watts RMS. This amplifier, coupled with the massive 12" long-throw woofer in a sealed enclosure, generates musically accurate deep bass with a minimum of distortion.

Your Atlantic Technology powered subwoofer will smoothly integrate with virtually all other brands of loudspeakers on the market. From the premium quality gold plated connectors to the clearly marked controls, this is one of the most versatile high performance subwoofers you can buy.

What's THX?

THX is a series of standards and technologies developed by Lucasfilm Ltd. (of Star Wars fame). These are intended to ensure that what you hear and see on your home system, as closely as possible, matches what the director heard and saw during the final production of the film. THX is intended to enhance every type of viewing and listening experience including the latest discrete multi-channel digital formats. *Please note however that THX is not a separate surround format.*



THX Select standards are based upon a room size of 2000 cubic feet (L x W x H). THX Ultra standards are based upon a room size of 3000 cubic feet. This does not mean these components must be used in rooms this exact size. The room sizes simply provide a frame of reference, as they indicate that these systems must deliver a minimum level of performance in these specified room sizes. Your 272 PBM is THX Select certified.

Features

Your Atlantic Technology powered subwoofer has been engineered using the latest technology and finest components available. It features:

- **A long-throw 12" composite cone driver with a vented 9.5 pound motor structure and 2" high temperature, 4 layer voice coil**

This powerful driver has a very stiff cone that acts as an almost perfect piston throughout its operating range. Its massive magnetic motor assembly and high temperature component parts deliver exceptional performance and reliability. In fact, its basic motor assembly is identical to that from our top-of-the-line 15" subwoofers!

- **Sealed enclosure design for low distortion and deep bass output**

Sealed enclosure woofer designs are inherently low in distortion and naturally deliver deep, smooth bass response with a gradual and predictable roll-off below resonance. As with all Atlantic Technology subwoofers, we have paid inordinate attention to giving you accurate musical bass reproduction along with terrific special effects.

- **A linear power high current Class A/B amplifier conservatively rated at 225 watts RMS**
This advanced amplifier is a fully discrete design utilizing audiophile grade component parts including a custom-wound, low-hum Torroidal transformer. The output stage is capable of very high current delivery for exceptional driver control. As a custom designed amplifier it has been precision matched and equalized to the 12" driver. Together they deliver powerful, controlled bass with great articulation and authority.
- **A useful in room working frequency range of 20Hz to 180Hz**
Many subwoofers offer specifications that look great on paper, but in real world use deliver less than promised. Atlantic Technology subwoofers are over-designed to ensure that they will deliver their rated performance in your room, when properly placed and adjusted.
- **An adjustable (55Hz to 140Hz) @ 18dB per octave low-pass crossover**
The steep upper end roll-off slope of 18dB per octave allows for much better bass integration with the satellite speakers while making the woofer less localizable.

Note: *If you are using a surround Processor/Receiver that includes its own filtered subwoofer output (or a THX Certified Processor/Receiver), we strongly recommend that you set the 272 PBM THX crossover control to the THX/Bypass position.*

- **Two low level inputs, two low level thruputs**
The thruputs allow daisy chaining of multiple subwoofers, or as a return path back to the processor.
- **Two high level inputs, two high level thruputs**
These let you connect the subwoofer to your amplifier using the amplifier's speaker outputs. Once again, you can daisy chain to another subwoofer using the unmodified signal that comes out of the thruput connectors.
- **A Phase Invert switch (Normal/Invert)**
This switch allows precise acoustic matching with satellite speaker systems whose output may be phase reversed. This switch also allows you to compensate for unusual room acoustics that occur when the woofer is physically separated from the midrange/high frequency units. Be sure to try the Phase switch in both positions when you set up the 272 PBM THX. Even if you've simply changed the built-in crossover settings it's a good idea to try the Phase switch in both positions, since the crossover control and the Phase switch acoustically interact with each other. Pay particular attention to the transition of bass from the woofer to the satellites, listening for smooth and well defined bass throughout the range.
- **A convenient front panel mounted Level Control**
- **Automatic standby operation, LED indicator**
Automatic standby features signal sensing turn-on with 7-10 minute turn-off delay. There's a front panel multi-color LED status indicator that lets you know when the unit is on or in standby. Automatic Standby can be defeated by placing the rear mounted switch in the Bypass position. If you find the front mounted LED distracting simply remove the grille from the enclosure, turn it over 180 degrees, and re-install it on the cabinet. The lower section of the grille frame has been designed to block the LED from view when you do this.
- **An AC cord power input socket.**
Your subwoofer comes supplied with a heavy-duty detachable power cord.
- **Designed and built to meet all current UL/CSA and European safety requirements**

Figure 1:
Amplifier panel
and controls for
Model 272 PBM
THX



Connecting Your Subwoofer

The Atlantic Technology System 272 PBM THX Powered Subwoofer is simple to hook up, offering several connection methods for maximum flexibility. Study the system diagrams starting on page 6. Once you have found the example which most closely matches your system, hook up your subwoofer(s) as shown in that diagram.

Warning: To prevent risk of electrical shock or damage to your equipment, always unplug all component AC cords before proceeding with speaker and component connections! The last step in wiring your system should be plugging in the AC cords!

Low Level Connection

We suggest using the low level (RCA jack) subwoofer line out or preamp output if your receiver/processor has one. Simply connect your subwoofer with high quality shielded cables as shown in the diagrams. Use the diagram that best suits your connection requirements. Please consult your processor/receiver manual for further information.

**Example 1:
Subwoofer
Line Out/
Low Level In**

Before using this connection method, please see the Note on page 3.

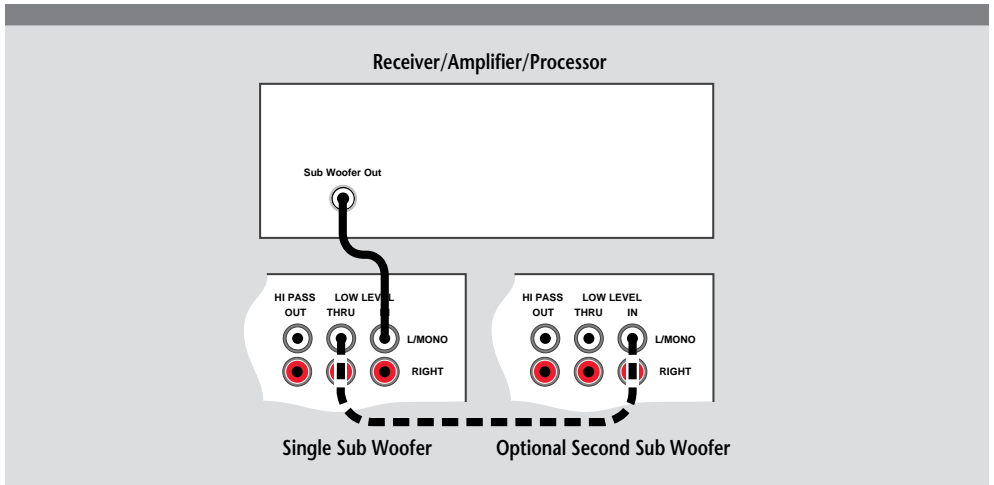

**Example 2:
Preamp Line
Out/Low
Level In for
1 Subwoofer**

This arrangement is for owners of stereo receivers/amplifiers with Preamp outputs. If your receiver/amplifier uses jumper links between the Pre-out and Main In, then you must remove them and use option 1 or 2. If your receiver/amplifier uses a switch instead of connectors, then use option 3.

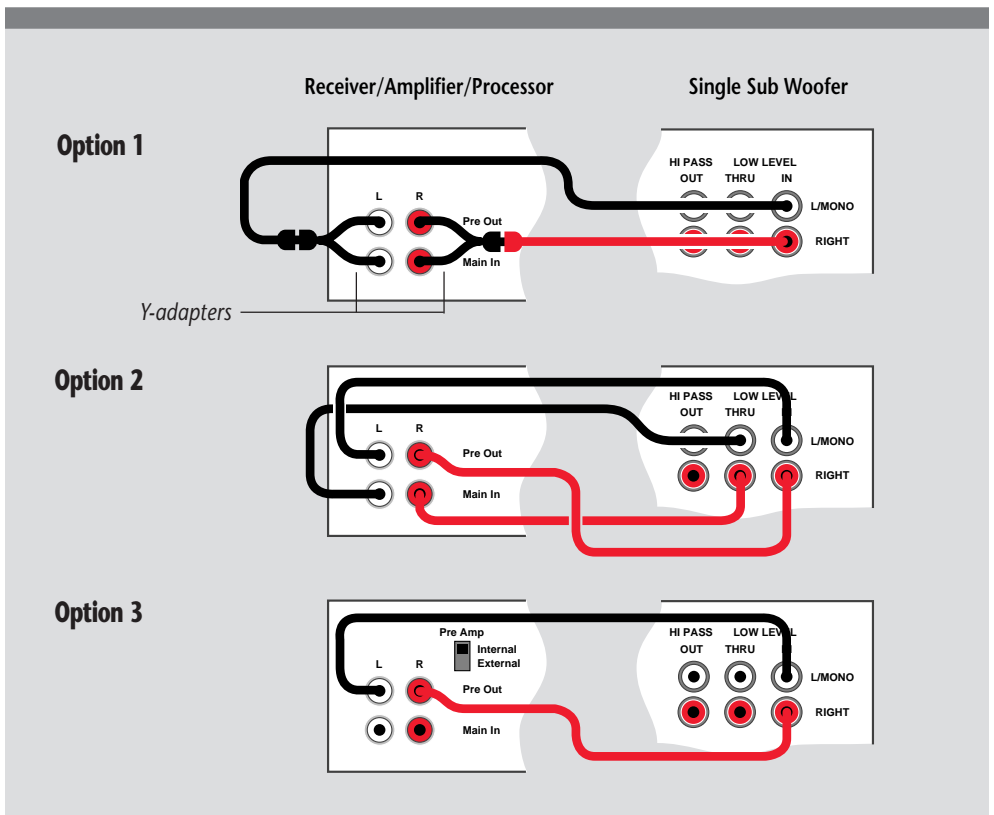

**Example 3:
Preamp Line
Out/Low Level
In for
2 Subwoofers**

Note that the L/MONO input is used on both subwoofers. Instead of Y-adapters, you may also use the THRU outputs to connect back to the Main Inputs as shown in Option 2 of Example 2.

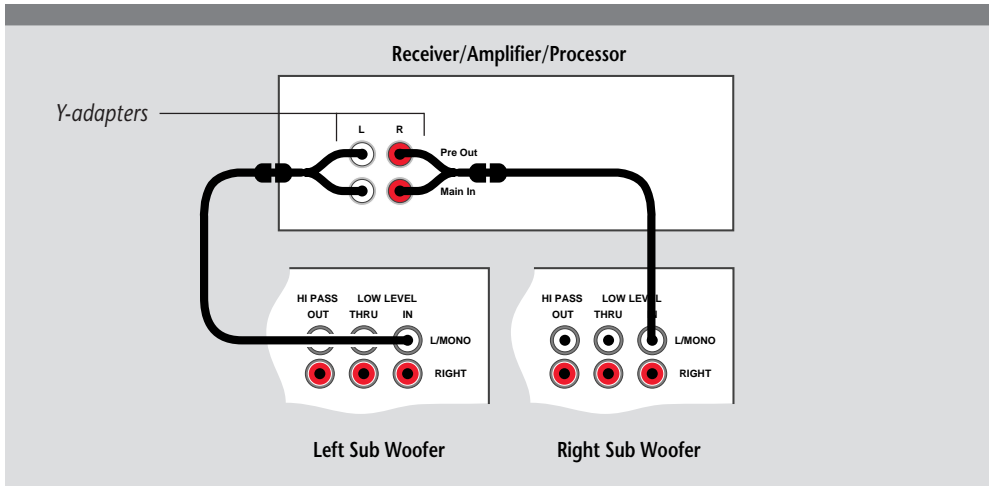

**Example 4:
Preamp Line
Out/Low Level
In using Hi-Pass
Out for
1 Subwoofer**

The line level Hi-Pass outputs send audio signals **above** the Lo-Pass filter setting to the main L and R power amplifier inputs. This keeps the low frequencies out of the left and right front speakers, allowing the subwoofers to reproduce the bass frequencies.

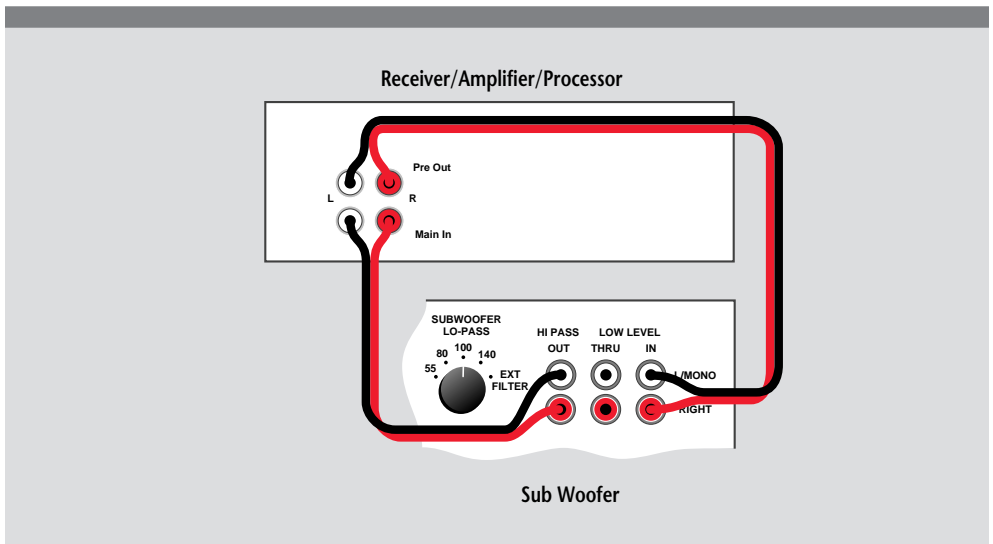

Note: These outputs are primarily intended for use in a two channel satellite/subwoofer system where the left and right speakers are small and not designed to reproduce bass. It is also useful when your receiver/amplifier/processor does not internally incorporate a low pass filter.

**Example 5:
Speaker Out/
High Level In for
1 Subwoofer**

This is the recommended method for connecting the 272 PBM THX to a discrete 5.1 channel. Please see the Note on page 3.

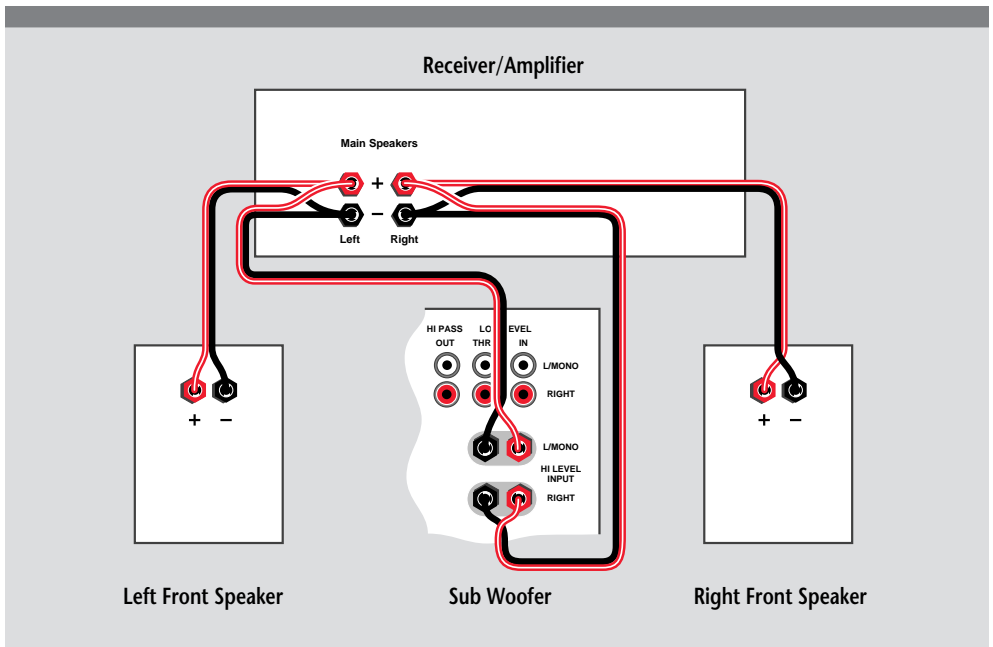

**Example 6:
Speaker Out/
High Level In for
2 Subwoofers**

This is the recommended method for connecting the 272 PBM THX to a discrete 5.1 channel receiver or amplifier. Please see the Important Note on page 3. You can also use the speaker level THRU outputs. Note that the L/MONO High Level input is used on both left and right subwoofers.

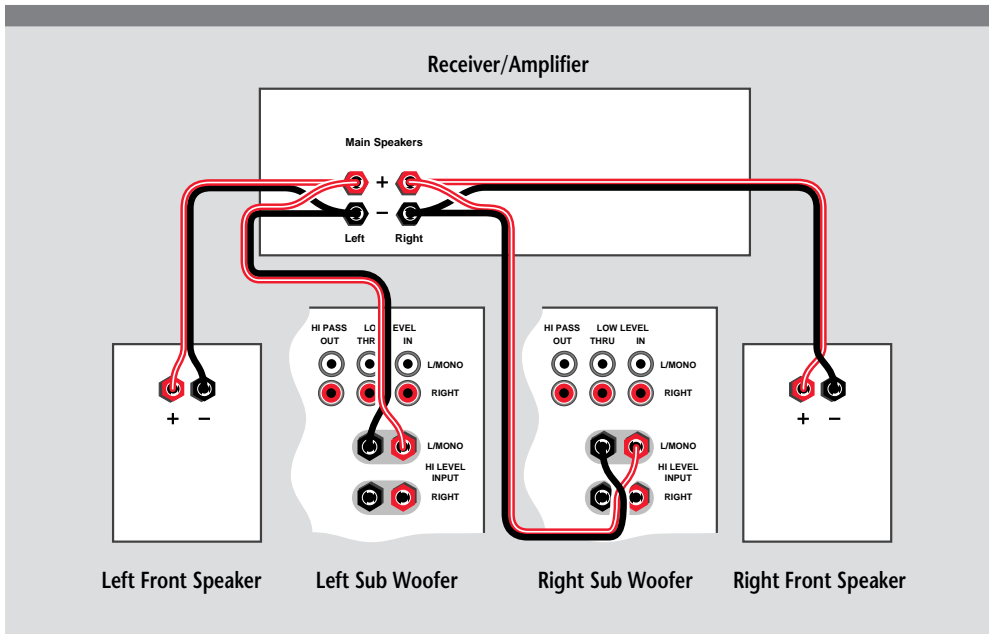

Using the Low level Thruput

If desired, you can run a low level stereo signal through the 272 PBM THX and out to another unit. This way you can add an additional subwoofer with minimal additional wiring. The signal that comes out of the Thruput jacks is identical to the input signal.

High Level Connection

Alternately, you may use the high level (speaker) inputs. We recommend that you connect your new 272 PBM THX Powered Subwoofer(s) using high quality wire of 16 gauge or larger. There are many respected manufacturers in the audio industry that specialize in speaker wire and interconnect cables suitable for your new system. Please consult your audio/video specialist for more specific information.

High level Thruput

If desired, you can run a high level stereo signal through the 272 PBM THX and out to another unit. This way you can add an additional subwoofer with minimal additional wiring. The signal that comes out of the Thruput jacks is identical to the input signal.

You can connect to the High level inputs by using a variety of connectors, or by removing 1/2" of insulation from each wire end, twisting the strands of wire together, placing the wire through one of the post holes and screwing down the nut tightly. It's important to observe polarity while making

Figure 2:
Gold plated 5-way
binding posts.
Accepts up to 10
gauge bare wire.

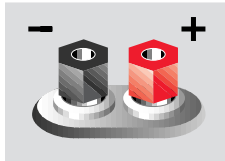

speaker connections: red (+) terminals on the amplifier to red (+) on the speaker, black (-) on the amplifier to black (-) on the speaker. Look carefully at the wires you are using and note that one of the wires in each pair will be marked by either the conductor color, printing on the wire jacket, a ridge on one side of the wire jacket, or a thread intertwined with the wire strands. By convention, the marked wire is connected to the red (+) terminal.

Power Connection

Connect the power cord to an AC outlet only after making all other connections to the subwoofer. This will avoid any chance of accidentally activating the subwoofer while wiring. Atlantic Technology **does not recommend** plugging the subwoofer into the switched outlet of an amplifier, preamplifier, or receiver. The power demands of the subwoofer amplifier may exceed the power rating of the switched outlet and may damage the equipment.

The 272 PBM THX is totally automatic in its operation. The automatic on/off circuitry will only activate the subwoofer in the presence of an audio signal from your system. After 7-10 minutes with no signal detected from the rest of the system, the amplifier will shut itself off and go back into standby mode. When the sub is in operating mode, the power LED located under the front grille will glow green. The LED will glow yellow in the Standby mode and power consumption in this mode is negligible. Standby operation can be completely bypassed by placing the Auto/Standby/Bypass switch on the 272 PBM THX amplifier to the Bypass position.

Placement and Operation

Generally speaking, the best location for your new subwoofer is the front of the room, in or close to a corner (Figure 3). Every room has its own unique sound characteristics, and flexibility in the exact placement of the subwoofer is always desirable. The closer the subwoofer is placed to a wall and especially a corner, the more and deeper the bass response you will hear. However, in some rooms, corner placement can produce a "one note" boomy effect. Under such circumstances the subwoofer may work better away from the corner. Experiment to find the best position in your room.

Helpful Hint: A particularly useful experiment is to place the subwoofer right at the prime listening position (move your couch or chair out of the way and put the sub in its place). Then play something with lots of good bass (preferably music), and walk around the room, listening to the subwoofer's response. When you locate an area that has ample amounts of well defined bass you've found a good potential place to locate the sub.

Figure 3:
Typical arrangement for a single subwoofer in a home theater.

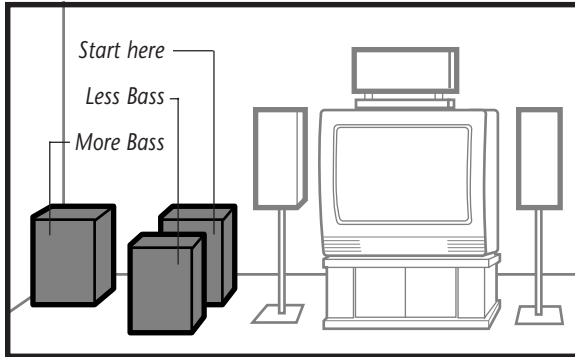

System Set Up

When setting up a complete home theater we strongly recommend that you use a Sound Pressure Level meter. Radio Shack® has a good one that is very affordably priced (approximately \$40). To use this meter, turn on your system, put the Processor/Receiver in the Test Mode and set its main volume control to 0dB. Sit in the prime listening position, set the SPL meter to the 70dB scale, Slow Response, and C Weighting. Now, holding the meter

pointed up and in front of you, let the system cycle its test tone from speaker to speaker and set every speaker to 75dB using the individual level settings in the Processor/Receiver. As tempting as it may be to set the subwoofer and/or surround speakers higher than 75dB, try them properly set and see if you can acclimate to these levels. Try watching several different movies and keep in mind that the goal is to have a system that sounds like you're actually "in the movie."

When using the latest discrete digital electronics which include internal level controls for all channels, we recommend setting the subwoofer's front mounted Level Control to its THX/Fixed position and using the Processor/Receiver's built-in subwoofer level control. Should you have difficulty achieving the correct subwoofer volume this way or should your Processor/Receiver not have a subwoofer level control, you can use the 272 PBM's front mounted level control to make this adjustment.

If you decide not to use an SPL meter try to set all the speaker levels the same using the Test Tones. Of course, this will be much more difficult without the meter, especially for the subwoofer.

Subwoofer Tuning Without an SPL Meter or Test Tones

Start your listening with the subwoofer Lo-pass control set at 80Hz or in the THX/Bypass position if you're using a THX Certified processor or unit with a built-in crossover. Set the phase switch to normal, and the front panel variable level control (Figure 4) to the THX/Fixed position. Play some music that you know has good bass content, and turn the level control up until you just start to hear the subwoofer working. Now, from your normal listening position, determine whether the subwoofer is playing loudly enough and filling in the bass frequencies of the music evenly. If adjustment is necessary, start by changing the setting in the processor or on of the front panel level control, if your processor lacks a subwoofer level adjustment.

Figure 4:
Front Panel Variable Level Control located behind the removable grille



If the bass seems too ponderous, boomy, or heavy, no matter how you set the level, try moving the subwoofer away from the wall/corner. If the bass seems too thin, try moving the subwoofer closer to the wall/corner. Small differences in positioning can make big differences in bass response. When you find a position that seems to work well, try switching the phase switch between its two settings, listening particularly to the transition from the subwoofer to the satellites.

How Much is Enough?

Sometimes people prefer more bass impact for movies than sounds natural when reproducing music. You may wish to determine both a video level and an audio level if you find yourself falling into this camp. Remember however, the most common error people make when setting up their system is to play the subwoofer (and surrounds) too loudly. Of course, the Home Theater Police will not arrest you for this act. But should you desire the most accurate overall reproduction, a well balanced sound from bass to highest treble is the best way to get it. Have fun. Experiment. Enjoy.

Dual Subwoofer Placement

Figure 5:
Assymetrical
arrangement for
2 subwoofers in
a home theater,
for example, one
closer to a corner
than the other

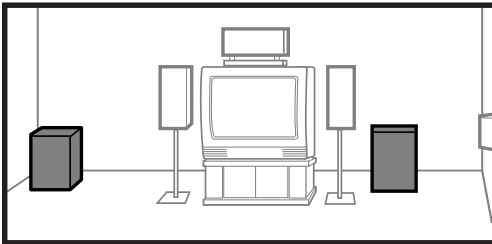

When two subwoofers are used you may wish to place them asymmetrically; that is, in slightly different positions in the room (Figure 5). This will reduce common mode room resonances that occur with symmetrically positioned subwoofers. You can also try placing the subwoofers in the same corner, if you wish. Experiments have shown this to be a viable means of producing smooth bass response in many rooms.

Using the Subwoofer Lo-Pass Control

When used with the complete System 270 THX, the 272 PBM THX Lo-pass control should be set at 80Hz unless you are using a processor with its own built-in crossover. The goal is to optimize the performance of the system by ensuring that the subwoofer and satellites produce a cohesive and well integrated sound "picture." The low frequency response of the System 270 THX satellites has been optimized to work with approximately an 80Hz crossover point.

Higher crossover frequencies pass more bass but can sound boomy and may be more easily localized to the subwoofer. Higher crossover frequencies may be suitable, however, when using very small satellites that have no real low frequency performance. Settings lower than 80Hz should be employed if you are using larger speakers that have extended bass response. This way, the subwoofer will only reproduce the very lowest bass frequencies that are in the range where the large main speakers begin to roll off. It's generally undesirable to have the main speakers and the subwoofer overlap too much. Larger speakers means a lower Lo-pass crossover frequency, smaller speakers means a higher Lo-pass crossover frequency. Consult the manufacturer's specified low frequency response for your main speakers to determine the appropriate Lo-pass setting on your subwoofer. In the end, however, a little time spent experimenting will generally result in dramatically better bass response.

The Phase Invert Control

A subwoofer operating out of phase with the rest of the system won't provide optimum low frequency performance. Also, the correct subwoofer phase can enhance room acoustics. Since there is so much variation in the industry regarding phase, and no standards have been established, a switch that will reverse the phase of the subwoofer is provided on the amplifier panel. Listen to a monaural musical source with strong bass content. (For example, you can use the mono switch on an FM tuner or preamp, or use a Y-connector on the outputs of one of your source components to get a mono signal.) Experiment with the position of the phase switch to get the most extended bass. It should be obvious which is the correct setting. In particular, there will be a smoother more integrated transition between the satellites and the subwoofer when they are properly phased.

A Word About Bass, Center Channel Modes, and System Set Up

Many surround processors and receivers feature a “Wide” and “Normal” mode for the center channel speaker. Atlantic Technology recommends that the center channel be operated in the “Normal” mode when using a powered subwoofer. The center channel speaker will sound more dynamic and the intelligibility of the system will generally be improved when in the “Normal” mode.

With discrete digital “5.1” channel systems (Dolby Digital AC-3, etc.) many controllers provide a Bass Management option, which lets you set the front and rear speakers in a limited bandwidth (Small) or full range (Large) mode. When using a subwoofer with Atlantic Technology speakers we recommend setting such a controller to the Small position for all the speakers in the system.

Care and Feeding of Your Subwoofer

The 272 PBM THX is constructed from 3/4" Medium Density Fiberboard. MDF is a non-resonant material ideal for speaker system enclosures. The outside is layered with a high quality black oak finished vinyl laminate. To clean the cabinet you may use a soft cloth either dry or *slightly* dampened with clean water. Be careful not to wet the cabinet or allow any water to enter the cabinet seams. Avoid placing your speakers in direct sunlight or near a source of heat that may, over time, damage the finish.

IMPORTANT: Save Your Boxes! *If you can do so, save the carton, packing pieces and plastic bags that came with your subwoofer. They will be useful in case you move or have to ship your subwoofer for any reason. In any case, save all packing materials until you are certain that the system has suffered no damage in shipment. If you find such damage, either visible or internal, contact your dealer immediately for the proper return procedure.*

Subwoofer Troubleshooting Guide

Once your subwoofer is set up, you should have many years of maintenance free enjoyment from your system. However, if you should encounter a problem, refer to the following guide to help you find the solution. If a problem persists, you should contact your local authorized Atlantic Technology dealer.

Problem	Possible Cause	Possible Solution
No bass output	AC power cord unplugged or plugged into a non-working outlet. Input cables not securely connected or defective.	Plug into a working outlet. Check all connections, then try another input cable.
Audible buzz or hum	Input cable not securely connected or defective. Single HI LEVEL input connected to the RIGHT channel only. Ground loop through antenna or cable TV system input.	Check all connections, then try another input cable. Connect to the LEFT input channel. Test by disconnecting antenna and/or cable system input leads. If hum goes away, install isolation balun(s) at that point.
More than one source audible	More than one source is playing.	All the subwoofer’s inputs are active at all times. Turn off unwanted source.
Weak bass	Subwoofer too far from the wall. VARIABLE INPUT LEVEL set too low.	Move the subwoofer closer to a wall or corner. Turn control up somewhat.
Weak bass: vague stereo image	Input source connected to HI LEVEL inputs is wired out of phase.	Check speaker wire connections and reconnect in proper phase.

Model 272 PBM THX Specifications

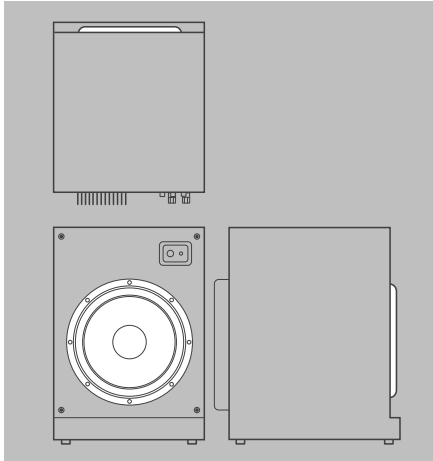

Type/Features

Powered subwoofer, sealed enclosure
 All discrete linear Class A/B power amplifier w/ dual power
 2", four layer vented aluminum voice coil, vented motor
 Switched 55, 80, 100, 140Hz bypass, 18dB/octave low pass output
 Variable low level stereo inputs and thruputs, low level output
 High level stereo inputs and thruputs w/5-way, gold-plated binding posts
 Absolute phase invert switch
 Auto signal sensing on/off/bypass

Bass Driver

12" long-throw composite cone

Output Power (rms)

225WRMS

Distortion (amplifier)

<0.025%

Frequency Response

20Hz – 180Hz ±3 dB

Input Impedance

High Level (speaker) 10kΩ
Low Level (line) 1kΩ

Peak Output

105dB SPL into 2000 cubic Feet

Dimensions (WxHxD)

15.75 x 21.50 x 18.50in; 400 x 546 x 470mm

Weight

62lbs/28.15kg

Power Requirements

110V AC 50/60Hz; 240V AC 50/60Hz

Specifications are those in effect at the time of printing. Atlantic Technology reserves the right to change specifications or designs at any time without notice. THX is a registered trademark of Lucasfilm Ltd. Dolby Digital, AC-3, 5.1, Dolby Stereo and Dolby Pro Logic are trademarks of Dolby Laboratories Licensing Corporation. DTS is a registered trademark of DTS Technology.

For Future Reference

Record your speaker serial number and date of purchase here:

Model Number _____

Serial Number _____

Date of Purchase _____

The serial number is found on the back of the speaker near the connecting terminals.



CAUTION: To reduce the risk of electric shock, do not remove the cover (or back). No user serviceable parts inside. Refer to qualified personnel.

WARNING: To reduce the risk of fire or electric shock, do not expose this appliance to rain or moisture.

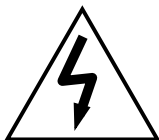

The lightning flash with arrowhead, within an equilateral triangle, is intended to alert the user to the presence of uninsulated "dangerous voltage" within the product's enclosure that may be of sufficient magnitude to constitute a risk of electrical shock to persons.



The exclamation point within an equilateral triangle is intended to alert the user to the presence of important operating maintenance (servicing) instructions in the literature accompanying the appliance.