

Atlantic
TECHNOLOGY

Instruction
Manual

System 250
High Performance Loudspeaker System

Models
251 LR
253 C
254 SR



System 250

High Performance Loudspeaker System

Welcome to Atlantic Technology's world of excellence in sound reproduction. Your new speaker system is precision crafted to give you years of enjoyable, trouble free service. This manual covers the **Atlantic Technology System 250** series of speakers for home theater. It will show you how to incorporate the following System 250 components into your present system, as well as how to set up a complete system. The **Model 262 PBM Subwoofer** is covered in a separate manual.

The **Model 251 LR Front Channel Speakers** are two-way systems for use with a quality subwoofer, such as the Atlantic Technology Powered Bass Modules. Each speaker contains two 4" polypropylene, long-throw woofers, and a 3/4" ferrofluid cooled tweeter in an acoustically inert MDF cabinet.

The **Model 253 C Timbre Adjusting Center Channel Speaker** contains two high power 4" polypropylene woofers and a 3/4" ferrofluid cooled tweeter. It is designed for use in home theater systems that use a Dolby Pro Logic decoder.

The **Model 254 SR On-Wall/In-Wall Surround Speaker** is intended for use in audio/video sound systems with a Dolby Pro Logic receiver (or a Dolby Pro Logic decoder and a surround amplifier). Each speaker has one 4" polypropylene woofer, as well as two 3-1/2" polypropylene mid-tweeters that are angled and phased to produce ambience without localization for movie surround sound tracks.

Although the speakers in the Atlantic Technology System 250 are acoustically and cosmetically matched to each other, they may also be used with a wide variety of other speaker systems.

Note: *The 254 SR is not intended for use as a regular right and left front channel stereo speaker or satellite. Its spatial performance characteristics are not designed for this purpose. In the Atlantic Technology 250 Series of components, the Model 251 LR fills this role.*

Connection

We recommend that you connect your new System 250 speaker components using high quality stranded wire of 18 gauge or larger for lengths up to 25 feet. Use 16 gauge or larger for longer runs of wire. Contact your local audio/video specialist for more specific information.

Warning: *To prevent risk of electrical shock or damage to your equipment, always switch off the amplifier or receiver when making connections to the speaker.*

Figure 1:
*Speaker Wiring
Terminals*

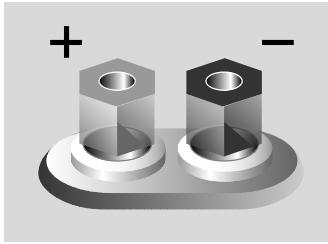

You can connect your System 250 speakers by using spade lugs or “banana” connectors, or by removing 1/2” of insulation from each wire end, twisting the strands of wire together, placing the wire through one of the post holes and screwing down the nut tightly.

It is important to observe polarity while making speaker connections: red (+) terminals on the amplifier to red (+) on the speaker, black (-) on the amplifier to black (-) on the speaker. Look carefully at the wires you are using and note that one of the wires in each pair is marked by either a different color, printing, ridges, or a thread intertwined with the wire strands. Conventionally, the marked wire is connected to the red (+) terminal.

Figure 2:
*Typical wiring
diagram for
speakers in a
home theater.*

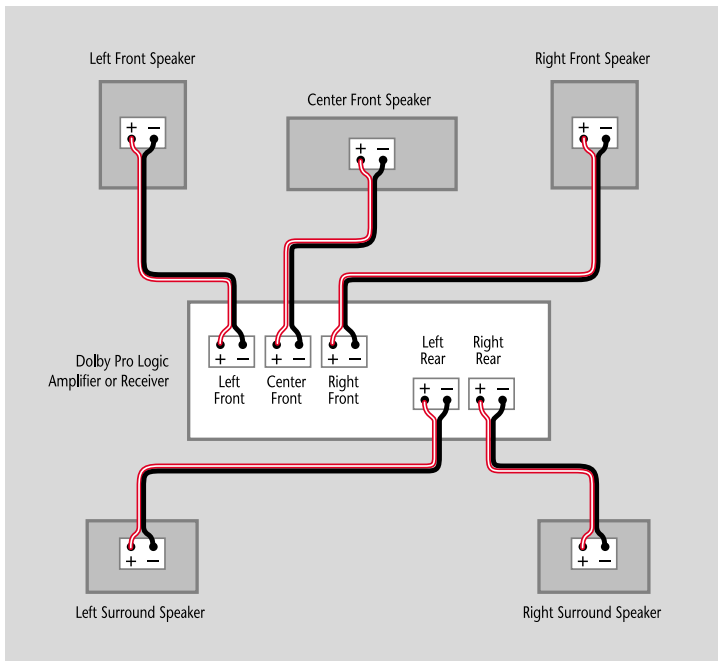

Whether you are connecting a complete System 250, or adding one speaker component to your present system, the wiring should look like the diagram in Figure 2. Before turning on the amplifier, be certain that no stray wire strands are touching across the two terminals as this might damage your amplifier.

Finally, check the polarity of your front speakers by listening to some music. If the sound seems hollow, spread out and has weak bass, recheck your connections for proper polarity and reverse the connections if necessary.

Placement

The design of the System 250 provides you with maximum flexibility when creating a large, seamless, acoustically accurate soundfield for your home theater or music system. The best placement of the various components will vary from system to system. Use the following placement guidelines and Figure 3 as a starting point. Feel free to experiment.

Home Theater

For a home theater system, place your Model 251 LR speakers on either side of the television. All of the System 250 speakers (except the Model 262 PBM Powered Bass Module) are magnetically shielded so that they will not interfere with your television picture. The left front and right front speakers should be far enough apart that you get a good stereo image, but not so far apart that the sound seems to come directly from the speakers, distracting you from the picture. If you are using a center channel speaker, a wider separation of the left and right front speakers is usually possible.

The Model 253 C should be placed directly on or under your television. Place the speaker base so that the foot cutouts are facing forward. Then, set the speaker on its base and tilt the speaker so that it points directly at the listener.

The 254 SR's size and shape allows greater flexibility in placement than most conventional surround loudspeakers. Due to their spatial characteristics, it is possible to place the speakers virtually anywhere, but usually the best location is nearly straight out to the sides of the primary listening area, either at ear level or 1-2 feet above.

Figure 3:
Typical arrangement for speakers in a home theater. For best results, place the surround speakers within the shaded areas.

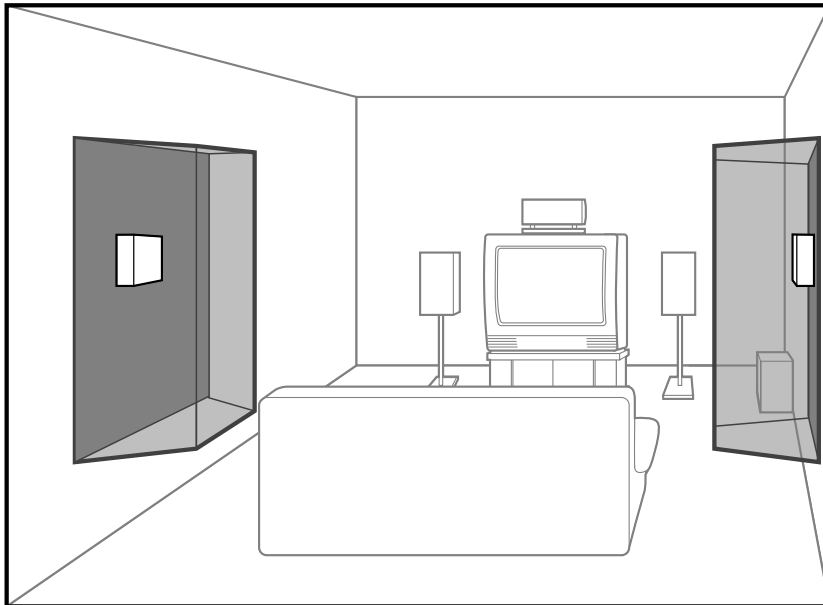

Music Only System (Model 251 LR only)

If you are setting up a music only system, begin with these general guidelines:

- The distance between your speakers should be about one-half their distance from your favorite listening position.
- The front of the speakers should point straight at you.
- The distance from each speaker to its three closest room surfaces should be different.
- In most rooms, you should not place your speakers in the corners.

Next, be creative! Try placing your speakers along the long wall instead of the short one. Toe the speakers in or point them straight ahead. Pull them away from the wall or push them close. Don't be timid. You will find that moving your speakers, even a few inches, can greatly change their sound.

Timbre Adjustments (Model 253 C only)

The home theater experience is best enjoyed when sounds remain consistent in tonal balance when panned across the soundstage. For that reason, the Atlantic Technology System 250 was designed with acoustically matching drivers.

To help achieve this goal when using front speakers from another manufacturer, we have provided two controls (Figure 4) on the rear of the 253 C enabling you to adjust its tonal characteristics to emulate those of your front left and right speakers.

Figure 4:
Timbre adjustment control knobs on back panel of 253 C Center Channel Speaker.

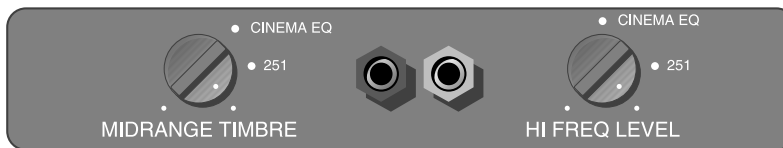

Begin the adjustment procedure by turning both control knobs to the “251” position. This approximates the Atlantic Technology 251 LR speakers. Next, use your Dolby Pro Logic receiver/decoder’s “test” mode to generate “hiss” from each speaker and adjust the 253’s controls for the closest match.

Although a perfect match is not usually possible, fine tuning the controls while watching high quality movies will generally yield excellent results. If most of your listening is Dolby Stereo movies, you may wish to adjust both controls to compensate for the natural brightness of many movie soundtracks. You may use the Cinema EQ position as a guide.

Note: Some Dolby Pro Logic decoders and receivers offer a choice of “normal” or “wide-band” modes for the center channel. The Model 253 C was designed to be used in the “normal” mode.

Mounting

The 251 LR and the 254 SR speakers can be mounted in a variety of ways:

On speaker stands. Atlantic Technology 156 ST speaker stands provide an ideal height (29" above the floor) and fit for most rooms. They are available in black or white.

On the wall. For greatest flexibility, use Atlantic Technology 157 WB wall brackets with their pivoting ball-and-socket joint.

To flush mount your speakers, we have provided metal key-hole brackets. Simply place the bracket over the oval recess on the rear of the speaker and fasten it using the enclosed #6 x 1" screws. Pilot holes are provided for both brackets.

For safety, please use suitably secured wall anchors (such as molly-bolts), or screws driven into wall studs.

On a bookshelf. Adhesive rubber feet are included.

In the wall. The Atlantic Technology 254 INRF in-wall kit includes all the necessary hardware and trim. (254 SR only)

Listening Levels and Power Handling

The power recommendation for these speaker components assumes that you will not operate your amplifier/receiver in a way that produces distortion. Even rugged speakers like System 250 can be damaged by a moderately powered system driven beyond its intended capacity. The harsh amplifier clipping that occurs in this situation will cause damage to the speaker system that is not covered by the warranty.

The System 250 will play very loudly when provided with enough power to do so. Again, consult your dealer or Atlantic Technology for additional information.

Care of your Speakers

Clean your speaker cabinets using a soft cloth moistened with a mild, non-abrasive glass cleaner being careful not to wet the individual drivers or the edges of the cabinet. After carefully removing the grilles from the speakers, clean them with a quick pass from a vacuum cleaner with a brush attachment. This should remove any dust accumulation.

Avoid placing your speakers in direct sunlight that may, over time, fade the finish.

System 250 Specifications

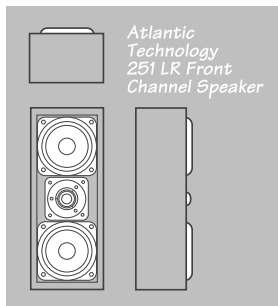

Atlantic
Technology
251 LR Front
Channel Speaker

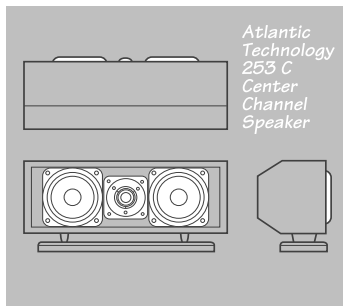

Atlantic
Technology
253 C
Center
Channel
Speaker

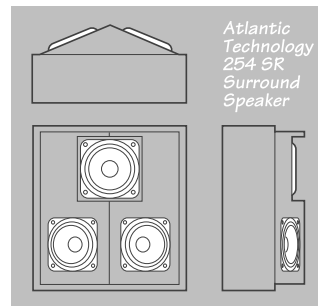

Atlantic
Technology
254 SR
Surround
Speaker

Description	251 LR	253 C	254 SR
Type	Sealed-box, 2-way	Sealed-box, 2-way, Adjustable Timbre	Sealed-box, spatially-enhanced surround speaker
Drivers	(2) 4" polypropylene (1) 0.75" dome tweeter	(2) 4" polypropylene (1) 0.75" dome tweeter	(2) 3.5" polypropylene (1) 4" polypropylene
Frequency Response (± 3 dB)	50Hz – 20kHz	80Hz – 20kHz	50Hz – 12.5kHz
Nominal Impedance	8 Ω	8 Ω	8 Ω
Sensitivity	90dB	90dB	90dB
Recommended Amplifier Power	10 – 150W	10 – 150W	10 – 150W
Size (W x H x D)	6.0 x 13.0 x 8.5in 152 x 330 x 216mm	15.0 x 6.75 x 7.75in (including base) 380 x 152–170 x 197mm	9.5 x 10.5 x 6.4in 241 x 267 x 163mm
Weight (each)	9.11lbs; 4.1kg	10.0lbs; 4.5kg	8.4lbs; 3.82kg

Specifications are those in effect at the time of printing. Atlantic Technology reserves the right to change specifications or designs at any time without notice.

Dolby Stereo and Dolby Pro Logic are trademarks of Dolby Laboratories Licensing Corporation.

For Future Reference

Record your speaker(s) serial number(s) and date of purchase here:

Model Number _____ Serial Number _____ Date of Purchase _____

Model Number _____ Serial Number _____ Date of Purchase _____

Model Number _____ Serial Number _____ Date of Purchase _____

The serial number is found on the back of the speaker near the connecting terminals.



343 Vanderbilt Avenue
Norwood, MA 02062
(617) 762-6300