

System 370 THX[®] High Performance THX Home Theater Loudspeaker System



Covers Models 371 LR, 373 C, and 374 SR

 **Atlantic Technology[®]**
INNOVATIVE HOME THEATER

343 Vanderbilt Avenue Norwood, MA 02062 (781) 762-6300

Instruction Manual

SYSTEM 370 THX

High Performance THX Home Theater Loudspeaker System

Congratulations on your purchase of the Atlantic Technology System 370 THX loudspeaker system. With proper care, your new speaker system will provide many years of trouble-free, high quality sound reproduction.

The System 370 THX was designed to provide accurate, uncompromised reproduction of high fidelity music and movie soundtracks. Nothing was spared in the development of the speaker components and cabinetry to provide superior performance, while maintaining an elegant, compact design that is easily integrated into the home.

What Is Home THX?



A Home THX audio system is the ultimate in sound for multi-channel home theater systems. The system incorporates a series of patented electronic and loudspeaker developments designed to reproduce all multi-channel sources accurately in the home environment. The driving force behind the creation of Home THX was the observation that, in the home environment, conventional audio components could not accurately reproduce soundtracks as they were originally intended. Two basic requirements were identified:

1. A need to correct the audible tonal and spatial errors caused by the reproduction of movie soundtracks designed for playback in large theaters in the smaller environment of the home.
2. A need to more accurately reproduce the complex and competing soundfields present in multi-channel soundtracks.

Why THX Loudspeakers?

Conventional high fidelity loudspeakers, even very expensive ones, are not ideally suited to the demands of multi-channel soundtracks. The **Atlantic Technology System 370 THX** is ideally suited to the accurate reproduction of high fidelity music and multi-channel sound. Here's why:

371 LR/373 C Front and Center Speakers

- **Wide horizontal dispersion** improves coverage of the listening area.
- **Focused vertical directivity** improves frontal localization and intelligibility.
- **Full dynamic range and frequency response**

374 SR Surround Speakers

- **Diffuse radiation** enhances envelopment and spaciousness.
- **Smooth power response** matches the tonal character of the front and center channels.
- **Full dynamic range and frequency response** for digital surround applications.

372 PBM Subwoofer

- **High output level** reproduces full dynamic impact.
- **Smooth in-room response** down to 20Hz.

A Word About Digital Surround Technologies and THX

It is important to remember that THX technologies work in conjunction with whatever processing technology it is paired. THX, on its own, is not a decoder or processor. It enhances and adapts the surround sound processor it is paired with to more accurately reproduce movie soundtracks in the home environment.

The new digital surround technologies, such as Dolby Digital® (AC-3®) and DTS®, offer dramatic improvements in channel separation and dynamic range over conventional multi-channel analog matrix formats such as Dolby Surround® and Dolby Pro Logic®. THX sound systems, with their outstanding dynamic, spatial, and tonal performance, are ideally suited to convey the benefits of digital multi-channel formats. THX technologies will continue to be essential for the accurate reproduction of all multi-channel sources, both now, and in the future.

Connection

We recommend that you connect your new System 370 THX speaker components using high quality wire of 16 gauge or larger. There are many respected manufacturers in the audio industry that specialize in speaker wire and interconnect cables who make suitable products for your new system. We recommend that you consult your local audio/video specialist for more specific information.

Warning: To prevent risk of electrical shock or damage to your equipment, always unplug all component AC cords before proceeding with speaker and component connections! The last step in wiring your system is plugging in the AC cords!

You can connect your System 370 THX speakers by using a variety of connectors, or by removing 1/2" of insulation from each wire end, twisting the strands of wire together, placing the wire through one of the post holes and screwing down the nut tightly. We recommend that you check your local electrical codes to make sure you are not using an improper connector.

Figure 1:
Gold plated
5-way binding
posts. Accepts
up to 10 gauge
bare wire

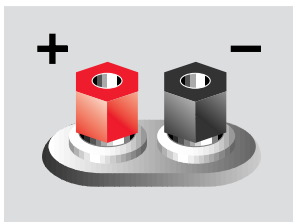

It is important to observe polarity while making speaker connections: red (+) terminals on the amplifier to red (+) on the speaker, black (-) on the amplifier to black (-) on the speaker. Look carefully at the wires you are using and note that one of the wires in each pair is marked by either a different color, printing, ridges, or a thread intertwined with the wire strands. By convention, the marked wire is connected to the red (+) terminal.

Whether you are connecting a complete System 370 THX, or adding one speaker or subwoofer to your present system, the wiring should usually look like the diagram in Figure 2. When installing an Atlantic Technology subwoofer into your system, refer to the subwoofer's instruction manual for other wiring options. Before turning on the amplifier, be certain that no stray wire strands are touching across the two terminals as this might damage your amplifier.

Figure 2:
Typical wiring
diagram for
speakers in a
home THX theater.

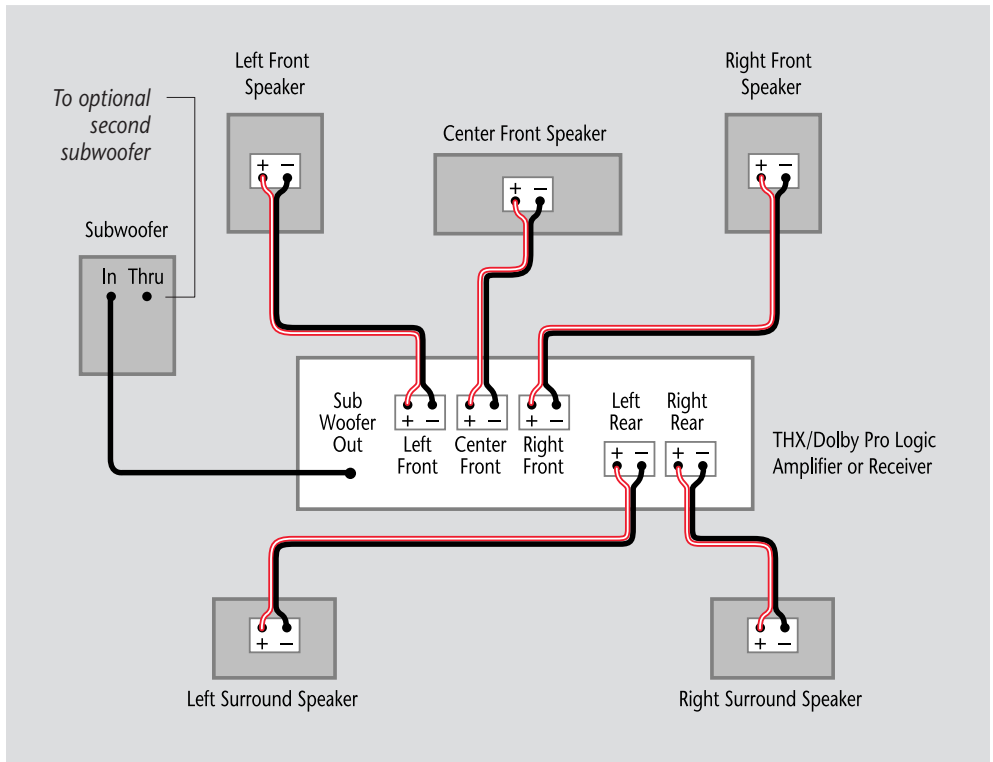

Finally, check the polarity of your front speakers by listening to some music. If the sound seems hollow, indistinct, and has weak bass, one of your speakers is out of phase. Recheck your connections for proper polarity and reverse the connections if necessary.

Important: The Atlantic Technology 370 THX loudspeaker system will attain its peak performance after a break-in period of approximately 50 hours at moderate volume levels. Higher volume levels will not hasten this break-in period.

Speaker Placement

Atlantic Technology speakers will provide excellent, satisfying sound when properly placed in your room. However, with the many variables in room layout and dimensions, there is no magical formula for determining the best speaker placement in every room. The following section contains general guidelines for speaker placement. Experiment to find where the speakers sound best in your particular room. Use the following placement guidelines and Figure 3 as a starting point. Remember that small changes in speaker positioning can make a big difference in the sound.

Mounting

The Model 371 LR and Model 374 SR speakers can be mounted in a variety of ways:

On the wall. To surface mount your speakers on the wall, we have provided two steel keyhole brackets already installed on the back panel of the cabinet. Simply place the large openings of the bracket over the heads of pan-head screws (securely screwed into wall studs or wall anchors), and slide the cabinet down onto the shaft of the screw. Ideally, the acoustic center of the speaker (the tweeter) should be within two feet of ear level when you are in a seated position.

On optional pedestal stands. The pedestal stands are provided with complete instructions and all necessary hardware required for installation. These stands allow placement flexibility and a stable base for a variety of floor surfaces, including deep pile carpeting. The height of the pedestal stand is matched to the speaker for optimum performance.

Positioning the Speakers

Place the **Model 371 LR Front Speakers** to the left and right of the TV screen. All of the System 370 THX speakers, except for the 374 SR surround speakers, are magnetically shielded and will not interfere with the video image. The left front and right front speakers should be far enough apart that you get a good stereo image, but not so far apart that the sound seems distant and distracting. Avoid placing the speakers too close to a corner or too close to the TV, and try to maintain an equal distance from the screen on both sides.

Figure 3:

*Typical arrangement for speakers in a THX home theater. For best results, place the surround speakers within the shaded areas. Note that the surround speakers are marked **Left** and **Right**. It is important that the speakers be placed correctly for proper imaging.*

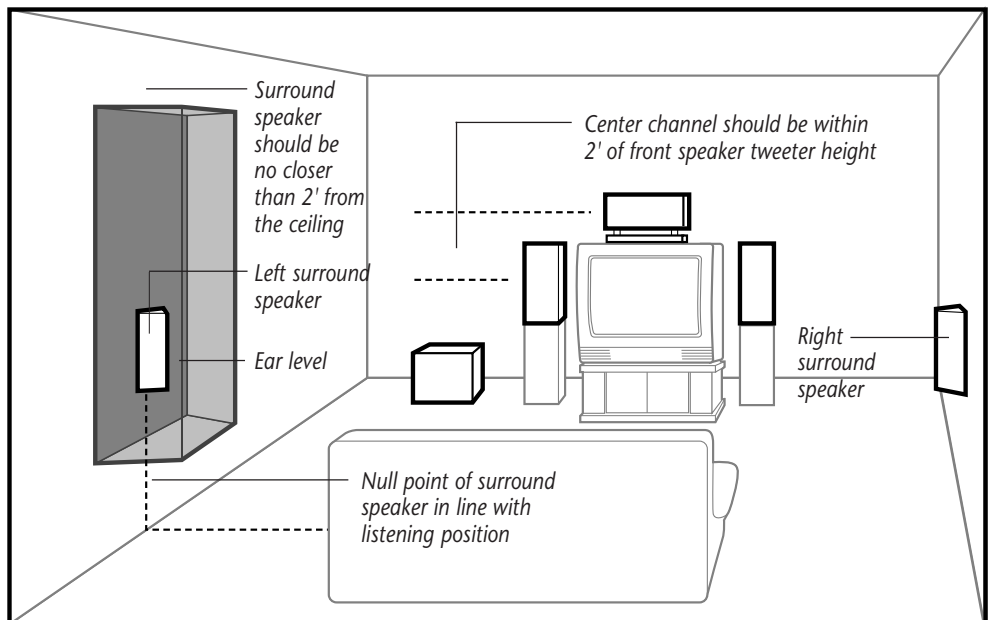

The degree of front speaker toe-in can affect the imaging and response characteristics of the speakers. In most rooms, the speakers will work well facing straight ahead or slightly toed-in towards the listener. Speakers that are placed close to the side walls may require additional toe-in to avoid a poor image and/or a forward midrange and treble response due to reflections from the side walls. Play some two channel stereo music and experiment with speaker positioning.

Note: *If the speakers need an excessive amount of toe-in to image properly, there may be a problem with the connection of the speakers or some part of the system may not be operating properly. Check all of your speaker wire connections for correct phase and verify that the associated components in the system are connected and functioning properly.*

The **Model 373 C Center Channel Speaker** should be centered between the left and right front speakers and above or below the TV screen. It should be tilted on its adjustable base to direct the sound toward the listening position. Ideally, the center channel speaker should be placed within two feet of the axis of the front channel tweeters. This placement is somewhat flexible, however, because of the directability of the 373 C on its tiltable base. The 373 C is usually placed on top of the TV, or above or below the screen in a front projection video system.

The **Boundary Compensation Control** on the rear panel of the 373 C provides a unique way to fine-tune the frequency balance of the speaker when it is placed on or near a reflective surface. In many situations, the unfortunate audible result of placing a speaker on top of a TV is a boost in the midrange response from the sound reflecting off of the TV screen. This can often result in harsh midrange and treble response and a blurring of the sound when you are sitting off to the side.

Once you have the speaker in position, put on some music or a movie with good center channel information. Sit down and listen for a few minutes. If you find the midrange response exaggerated, flip the switch to the **boundary compensation** position. This will reduce the level of midrange frequencies.

Conversely, if there doesn't seem to be enough midrange frequencies, if voices sound muffled for example, flip the switch to the **free air, THX reference** position to increase these frequencies.

For free-air use, and to meet THX specifications, keep the switch of the boundary compensation control in the THX position.

The **Model 374 SR Surround Speakers** should be placed at the sides of the room with the null (the point of the triangle between the two sets of drivers) of the speakers aimed at the listening position. Height of the surrounds should be between ear level and two feet above ear level.

If there is more than one row of seats, the surround speakers should be at the sides of the room at the geometrical center of the seating positions. Some people prefer to have the surround speakers mounted high up on the side walls, slightly behind the listening position. If this is the case, the speaker should be mounted upside-down to position the tweeters at the bottom of the cabinet. This will acoustically position the speaker lower on the wall. This mounting position can provide a larger sense of "space" and may be the only choice in some rooms.

Figure 4:
Boundary
Compensation
Control on rear
panel of 373 C.

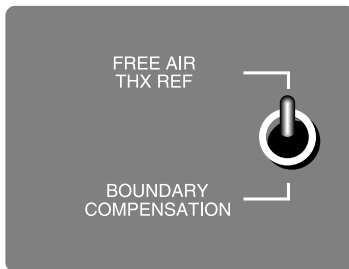

The **Model 372 PBM Powered Subwoofer** should be placed in the front of the room, close to a corner. Every room has its own unique sound, and flexibility in the exact placement of the subwoofer is always desirable. In general, the closer the woofer is placed to a corner, the more bass response you will hear. However, in many rooms, corner placement can produce too much bass and the subwoofer will work best well away from the corner. Experiment to find the best position in your room. Refer to the wiring diagrams in the subwoofer's instruction manual for the correct wiring scheme for your particular setup. Then proceed with listening.

Subwoofer Tuning

Start your listening with the high-pass filter set at 80Hz, the phase switch set to normal, and the level control all the way down (counterclockwise). Play some music that you know has good bass content, and turn the level control up until you just start to hear the subwoofer working. Now, sit in your normal listening position and determine whether the subwoofer is playing loud enough and filling in the bass frequencies of the music evenly. If it needs adjustment, change the setting of the level control to compensate. If the bass still seems too heavy, move the subwoofer away from the corner. If the bass seems too thin, move the subwoofer closer to the corner. Small differences in positioning the subwoofer can make big differences in the overall bass response. When you find a position that seems to work well, try switching the phase switch between its two settings, listening closely for the smoothest bass response. **Remember, the most common error is to play the subwoofer too loudly.**

Listening Levels and Power Handling

The power recommendation for these speaker components assumes that you will not operate your amplifier/receiver in a way that produces distortion. Even rugged speakers like System 370 THX can be damaged by a moderately powered system driven beyond its capabilities. The harsh amplifier clipping that occurs in this situation may cause damage to the speaker system that is not covered by the warranty. The System 370 THX will play very loudly when provided with enough clean power to do so. Don't starve your system for power! There are several suitable receivers, integrated amplifiers, and multi-channel power amplifiers commonly available. Consult your local audio/video specialist for additional information.

Care of your Speakers

Clean your speaker cabinets using a soft cloth and a mild, non-abrasive glass cleaner (such as Windex), being careful not to wet the individual drivers or the edges of the cabinet. **Spray the cloth, not the cabinet.** Do not rub, but lightly wipe the dust and fingerprints from the surface. A dusty grille is easily cleaned by gently using a vacuum cleaner with a brush attachment on the grille fabric. Avoid placing your speakers in direct sunlight or near a source of heat that may, over time, fade the finish.

Important: Save Your Boxes! *If you can do so, save the cartons, packing pieces, and plastic bags that came with your speakers. They will be useful in case you move or have to ship your loudspeakers for any reason. In any case, save all packing materials until you are certain that the systems have suffered no damage in shipment. If you find such damage, either visible or internal, contact your dealer immediately for the proper return procedure.*

System 370 THX Specifications

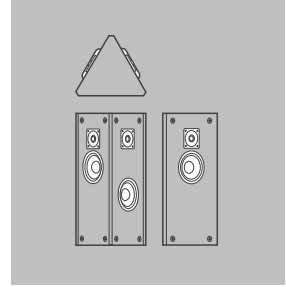
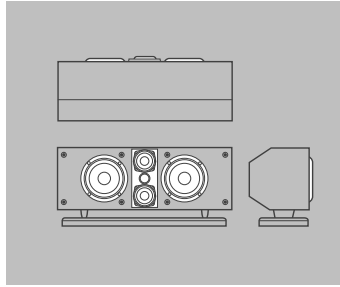
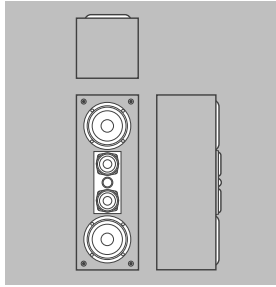

Model	371 LR	373 C	374 SR
Type	Sealed-box, 3-way D'Appolito	Sealed-box, 3-way, D'Appolito	Sealed-box, TwinPolar™ (V-pole) spatially-enhanced
Drivers	(2) 6-1/2" coated composite molded graphite woofers; (2) 3-1/2" coated composite molded graphite midrange drivers; (1) 1" silk dome tweeter, neodymium magnet, ferrofluid cooled	(2) 6-1/2" coated composite molded graphite woofers (2) 3-1/2" coated composite molded graphite midrange drivers; (1) 1" silk dome tweeter, neodymium magnet, ferrofluid cooled	(2) 5-1/4" coated composite molded graphite woofers; (2) 3/4" silk dome tweeters, neodymium magnet, ferrofluid cooled
Frequency Response (±3dB)	80Hz – 20kHz	80Hz – 20kHz	80Hz – 20kHz
Nominal Impedance	8Ω	8Ω	8Ω
Crossover Frequency	350Hz – 4.5kHz	350Hz – 4.5kHz	3.5kHz
Sensitivity	91dB	91dB	87dB
Recommended Amplifier Power	100 – 200WRMS	100 – 200WRMS	100 – 200WRMS
Magnetic Shielding	Yes	Yes	No
Size (W x H x D)	7.5 x 23.65 x 11.375in 190 x 600 x 288mm	25.75 x 10.0 x 10.5in with base 655 x 254 x 267mm with base	7.875 x 18.7 x 7.25in 200 x 475 x 184mm
Weight (ea., unpacked)	27lbs; 12.25kg	25lbs; 11.35kg (28lbs; 12.71 with base)	12lbs; 5.45kg

Specifications are those in effect at the time of printing. Atlantic Technology reserves the right to change specifications or appearance at any time without notice. THX and Lucasfilm are registered trademarks of Lucasfilm Ltd. Dolby Digital, AC-3, Dolby Stereo and Dolby Pro Logic are trademarks of Dolby Laboratories Licensing Corporation. DTS is a registered trademark of DTS Technology.

For Future Reference

Record your speaker(s) serial number(s) and date of purchase here:

Model Number	Serial Number	Date of Purchase
_____	_____	_____
Model Number	Serial Number	Date of Purchase
_____	_____	_____
Model Number	Serial Number	Date of Purchase
_____	_____	_____

The serial number is found on the back of the speaker near the connecting terminals.